

THE PROPERTY OF THE DRAWING IS ESTABLISHED BY LAW. IT IS FORBIDDEN TO PRODUCE OR SHOW IT TO THIRD PART. WITHOUT A WRITTEN AGREEMENT.

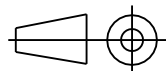
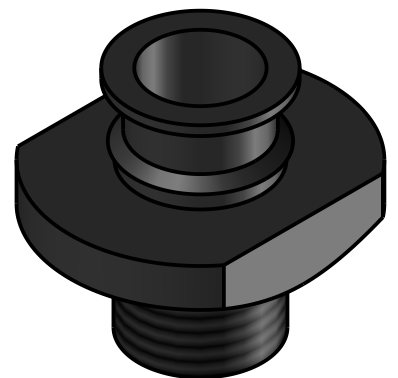
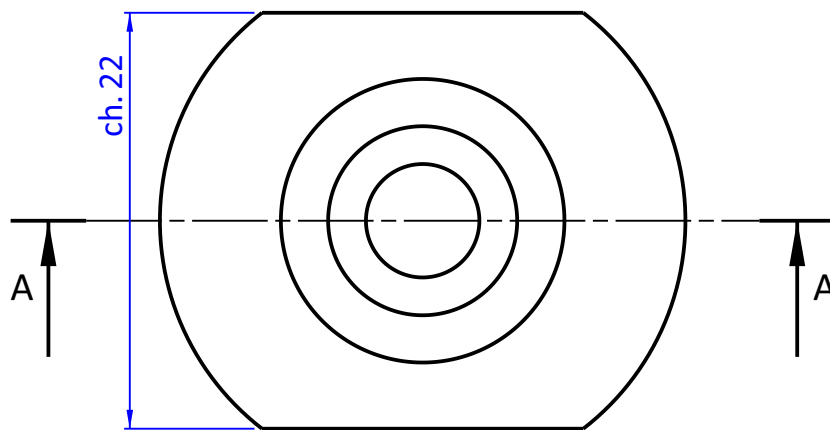
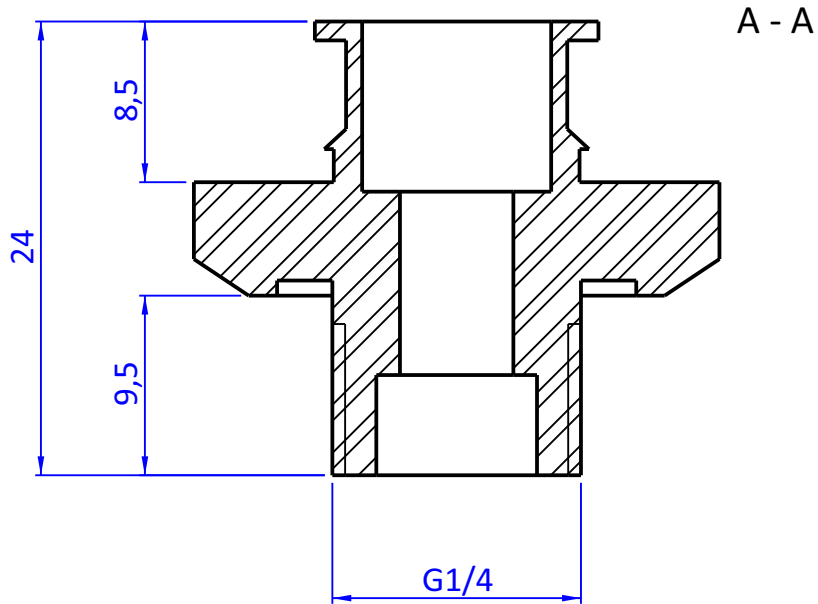

DESIGNED FROM
FPS Automation

REVIEW
A

DATE
02/09/2022

WEIGHT
0,011kg

CODE
CA.08.09.003

Format **A4**
UNI 936-76

GENERAL TOLERANCE
UNI - ISO 2768
CLASSE **f**

DESCRIPTION
CA.08.09.003